

WE LOVE TECHNOLOGY

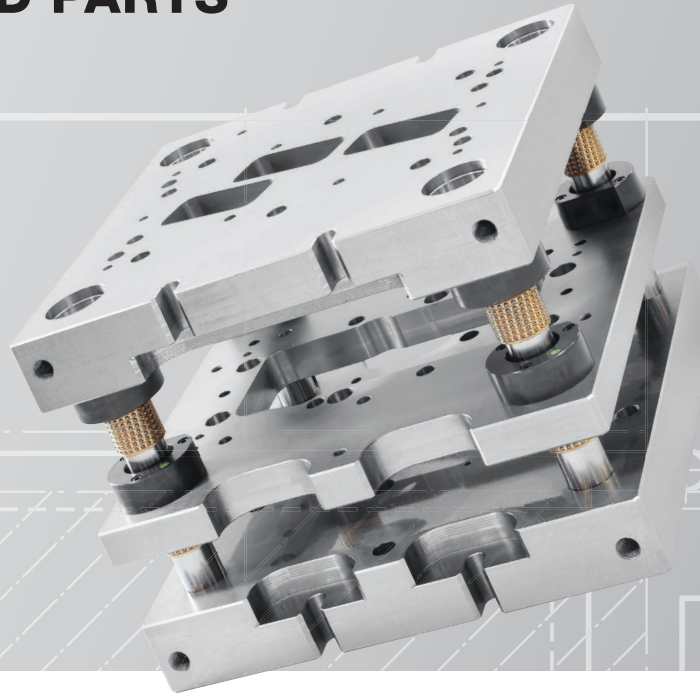

INNOVATION FROM TRADITION
STANDARD PARTS



MEMBER OF THE LÄPPLE GROUP



DIE SETS

THE STABLE BASE FOR YOUR TOOLS

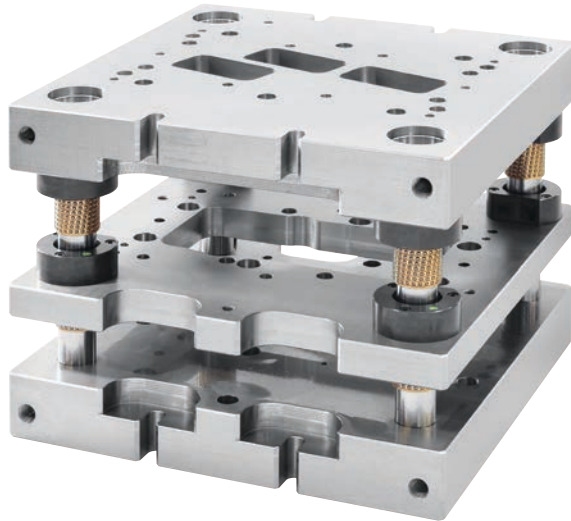

DIE SETS

PER DIN / ISO AND COMPANY STANDARDS

- Our product range includes die sets as per DIN / ISO and company standards made of steel, cast or aluminium with slide or ball guide. We also distribute small presses, precision tool assemblies and quick change tool sets.
- On request, we deliver to you these die sets with other guide elements, such as roller guides, for example. Of course, we also manufacture individual custom-made pillar guide sets.
- Those who prefer cost-effective die sets will receive the ECO-LINE steel pillar set, a set with bronze-plated sliding guide bushes.

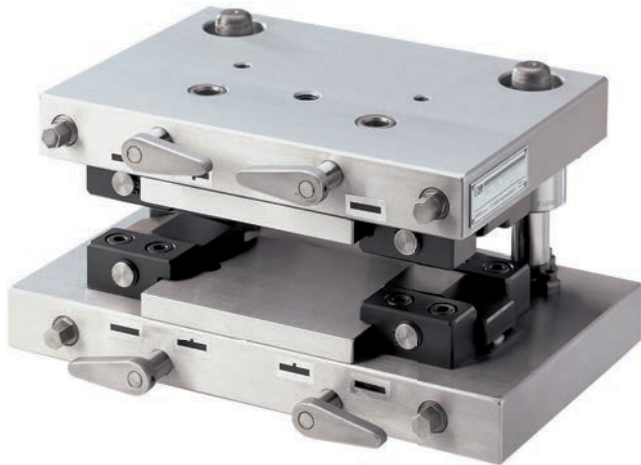

TOOLING PALLET DIE SETS IF YOU HAVE TO BE QUICK AGAIN...

... YOU SHOULD NOT BE WITHOUT OUR TOLLING PALLET DIE SET.

The advantages clearly speak for themselves - simple, fast and cost-effective! Market-oriented reaction during the manufacture of small parts series. While the basic set remains in the press, the clamping of slide-in tools can be carried out quickly. This favours a reduction in tool costs and shortening of the set-up times.

Various sizes offer work surfaces up to 350 x 210 mm.

PRECISION GROUND PLATES AND FLAT BARS IN STANDARD- AND SPECIAL DIMENSIONS



MANY DIMENSIONS FOR THE REALIZATION OF YOUR IDEAS

We can supply to you aluminium plates in standard dimensions (~ ISO 6753-1). Special dimensions are available on request. Furthermore, we offer flat and square tool steel, pre-ground or precision-ground as per DIN 59350, in various dimensions and materials.

Our standard materials for steel plates are St52-3 and aluminium (AlZnMgCu 1,5 F53 - 3.4365). This material is also used for our standard die sets.

Should you prefer another material, this is also available.

LIFTING AND CLAMPING DEVICES OUR RICH STANDARD PARTS ACCESSORIES



THE SAFETY FOR YOUR TOOL TRANSPORT

Our extensive standard parts accessories include, among others, clamping devices, clamping and lifting journals as well as hoisting gear. For required sizes and weight groups, we stock support and mounting elements, which are intended for the safe transport of tools that weigh up to 63,000 kg.

The load handling devices meet the requirements of the Machinery Directive 2006/42 / EC on the CE marking.

Declaration of Conformity and operating instructions in the FIBRO available at Phone no .: 06266-73-0 or Email: info@fibro.de

GUIDE ELEMENTS

PRODUCTION ENGINEERING POSSIBILITIES



PRECISION AT THE HIGHEST LEVEL

The production engineering possibilities of FIBRO allow the manufacture of three even finer tolerance classes for the already

exact guide pillars and bushes. This makes it possible to achieve exactly defined guide clearances for sliding guides or initial loads of ball guides.

Depending on the application, we offer guide elements for self-assembly of custom-made die sets or devices in various designs. These include sinter sliding, ball or roller guides as well as low-maintenance sliding elements for round or flat guides.

Especially our ball guides are not only intended for mould making and tool manufacture. It does not matter whether in measuring or dental technologies, mechanical engineering or in the optical industry. If precise movements are to be carried out, our ball guides prove themselves time and again.

Our team will gladly lend you its support, should you have any questions regarding the correct pairing of guide bushes and pillars.

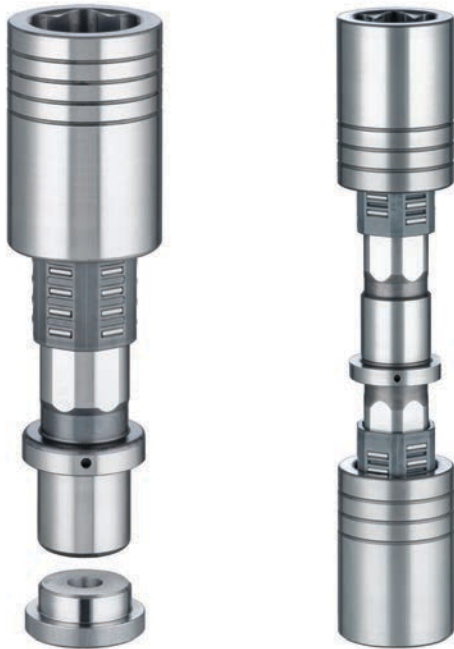

PRECISION THROUGH NEEDLE ROLLERS GUIDE UNIT MILLION GUIDE

Printed circuit boards, chip cards, LED's, semiconductors or lids for the food industry, all of which are manufactured with foil stamping technology, require a die set with high precision guides in order to achieve an extremely narrow cutting gap.

With a high contact surface for needle rollers, our guide unit MILLION GUIDE is best suited for this purpose.

This way, the guide unit MILLION GUIDE achieves a high level of rigidity, stability and a very high guidance accuracy.



THE ALTERNATIVE ECO-LINE GUIDE ELEMENTS

The ECO-LINE guide elements provide a low cost, but not inferior alternative to the other guide bushes with collar or flange. They are interchangeable with them easily and useful if you do not have high precision requirements.

THE ECO-LINE PRODUCT RANGE INCLUDES SO FAR:

- Guide pillars ECO-LINE
- Guide pillars with collar ECO-LINE
- Guide bushes with collar, bronze plated, ECO-LINE
- Guide bushings with collar / flange, bronze with solid lubricant rings, ECO-LINE

The ECO-LINE guide bushes with solid lubricant rings are the link between the guide bronze guide bushes with solid lubricant nests and the guide bushes to DIN-ISO. They meet the requirement for a stable guiding with low maintenance.

PRODUCTS FOR (ALMOST) EVERY APPLICATION OILLESS GUIDE ELEMENTS



Our maintenance-free sliding elements found in tool and machine for linear and rotary movements for years use. The base material is supplemented by solid lubricant depots, which provide lubrication. After this one-time initial lubrication sliding elements over a long period maintenance free. The fullness of this product range is vast range of applications. In addition, of course, also special designs according to your wishes at any time.

GROUND PRECISION COMPONENTS

PUNCHES WITH BEVEL/FLAT HEAD OR CYLINDER HEAD ACCORDING TO DIN REGULATIONS



THE BE-ALL AND END-ALL

Our range of precision parts include punches with bevel/flat head or cylinder head according to DIN regulations or made to drawing in 8 different material qualities as well as quick-change punches.

All these high-wear parts benefit from the constant monitoring of quality that characterizes our entire standard parts fabrication process, from receipt of raw materials through to dispatch of the finished product. The result – an exceptionally long die life – cuts costs dramatically in the punching shop by reducing the need for tool changes.

ALSO AVAILABLE:

- Retainers for punches and ball-locked punches
- Gauge pins with and without handle, as single pins and also in sets
- Gauge pins DIN 2269
- Dynamic stripper elements (DAE)
- ACCU-LOCK Fixture device for ball-lock punches
- Punches with tapered head

DESIGNED AS A REPLACEMENT FOR TODAY'S SERIALLY
PRODUCED PARTS PREVIOUSLY MANUFACTURED
INDIVIDUALLY: BOLT LOCK SYSTEM

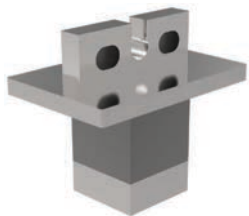

The development of the BOLT LOCK system is a logical continuation of today's quick-release systems for punches beyond a shaft diameter of 40 mm.

Since the punches are available for any geometries, the compact system can be used for a variety of applications. An example of this is the use of punches to cut sheet metal parts, which are not manufactured as individual parts, but rather mainly as multiple parts for economic reasons.

Large perforations in structured parts of the car body can be manufactured without a problem using the system.

You can also use the Bolt-Lock system in progressive dies for punching and piercing the necessary shape into the sheet metal stripe. The system makes a valuable contribution to the further standardisation of tools and connected advantages in regard to time, costs and quality.

- Designed as a replacement for today's serially produced parts previously manufactured individually
- Punches available in standard shapes and customer-specific special shapes according to data record
- High quality due to automated serial production
- Cost savings in design due to CAD standard parts library
Data in the currently common data formats can be called worldwide directly through fibro.partcommunity.com and is thus always up-to-date free of cost.
- For CATIA V5 users a parametric CATIA model is available.
- Low spatial requirement as conventional system and therefore also an option for saving operations.
- Geometrical changes of the cutting contour do not affect the retaining plate, thus permitting cost savings in case of changes.
- Low mounting effort in tool maintenance, quick-release system
- Punches are provided with extraction thread in the standard version. Lateral borehole in the case of cutting form width $W < 20$ mm.

(DAE) DYNAMIC STRIPPER ELEMENTS

The Dynamic Stripper (DAE) is used in stamping tools for stamping processes with a material thickness of up to 2 mm. The DAE is located beneath the matrix.

The shape can be compared with a slotted sleeve (similar to collet chucks). After the actual stamping process, the cutting punch, together with the adherent slug, dips into the DAE. In doing so, the DAE expands and rests against the cutting punch. During the return stroke, the DAE removes the slug from the cutting punch, protecting the tool and the product from damages



FOR BALL-LOCK PUNCHES ACCU-LOCK FIXTURE DEVICE



The new holding inserts for quick-change punches are available in two versions, light and heavy-duty. They are installed directly in the tool plate; the previously necessary additional mounting plate is no longer required. Only two holes for the punch and the holder/bracket have to be drilled.

Was it in the past not possible to place quick-change punches close to each other due to the external shape of the mounting plate, the ACCU-LOCK holding inserts are practically no longer an obstacle.

Due to the design of the mounting plates, it is not possible to place the punches close together - now a few millimeters distance are no longer a problem. For example, the entire structure of tool slides can be made significantly more compact. FIBRO offers the holding inserts as individual parts and also in the future, with a multiple mounting plate made according to customer requirements, fully assembled.

SPRINGS

COMPRESSION SPRINGS



HIGH PERFORMANCE COMPRESSION SPRING TO DIN ISO 10243

We manufacture and supply special spiral compression springs, steel springs and spring elements for punching and metal forming technologies as well as diaphragm springs and spring shape elements.

The spring type used depends on the individual requirements. We have four load groups that can be used in either tool manufacture, engineering or in the construction of jigs and fixtures.

The permissible value of the shear stress and the spring oscillating stress differential depends on the spring material used. FIBRO special spiral compression springs are manufactured from 50CrV4. The specially milled profile allows a high level of alternating and continuous loads and is ready for operations at working temperatures of up to 250°C.

SPRINGS

ELASTOMER SPRINGS



ELASTOMER SPRINGS TO DIN ISO 10069-1

We offer a wide range of elastomer springs, spring shape elements, ejectors and scrapers made of polyurethane rubber. Under the column „elastomers“, you can convince yourself that FIBROFLEX® elastomer springs cannot only be used as pure spring elements but also as forming elements.

During continuous loads, elastomers lose some of their ability to regain the original shape. Over time, deformation residue occurs, i. e. the elastomer settles. Depending on the spring displacement utilisation, the tendency towards initial sagging relating to the original spring height amounts to 8 - 10 %.

SPRINGS

GAS SPRINGS



METHOD OF OPERATING OF THE GAS SPRING

Compact gas springs represent a substantial step forward in spring technology and are also available for high-temperature environments. Apart from the stipulated Pressure Equipment Directive 2014/68/EU, some of our gas springs are equipped with additional safety features. „The Safer Choice“ are unique safety advantages that include overstroke protection, overpressure protection and piston rod protection. This puts our spring among the safest on the market.

Whether reshaping, cutting or punching, nearly all renowned tool manufacturers rely on the versatility when using FIBRO gas spring. A gas spring is a self-contained receptacle, which is filled with nitrogen gas. A piston rod moves into the space and compresses the gas located inside. Because the gas wants to expand again, the piston rod is forced out at a defined force (force = pressure x surface).

PRODUCT RANGE OF THE GAS SPRINGS :

- Gas springs Standard, to ISO
- Gas springs with increased spring force - HEAVY DUTY
- Gas springs with increased spring force and low build height – POWERLINE
- Compact-Gas springs
- Gas springs CX – COMPACT XTREME
- Gas spring LCF, damped
- Gas springs, SPC, cushioned – SPEED CONTROL
- Gas spring, DS for Die Separation
- Controllable gas springs
- Stock lifter
- Composite plate systems
- Manifold systems
- Air springs to VW Standard
- Wireless Pressure Monitoring (WPM) of gas springs

The program is supplemented by a wide range of Pressure plates, tube systems, fittings for gas filling, the compound arrangement and pressure monitoring instruments.

SPRINGS

THE WIRELESS PRESSURE MONITORING (WPM) SYSTEM



WIRELESS MONITORING

The optional Wireless Pressure Monitoring System (WPM) (patent pending) wirelessly monitors the pressure and temperature of FIBRO gas springs. Before a defective part is produced, the press operator receives a message from the WPM and can take appropriate action.

ADVANTAGES:

- Around-the-clock monitoring and documentation
- Early warning signalling prevents the production of unacceptable parts.
- Pre-emptive wear detection and targeted troubleshooting
- Avoidance of downtimes and follow-up damage
- Minimisation of points of leakage
- Streamlined construction and assembly
- Optimised maintenance intervals and reduction of maintenance and repair costs.



SPRINGS

SAFETY FEATURES

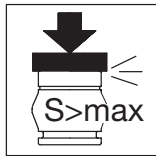

Overstroke protection

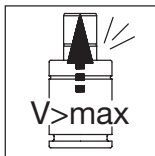

Return stroke protection

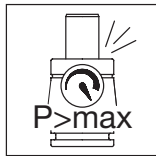

Overpressure protection

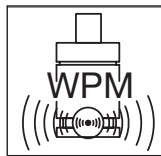

WPM system

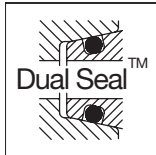

The Dual Seal system



The Flex Guide system

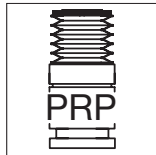

PRP system



PED approval

THE SAFER CHOICE

At FIBRO, safety has always been a top priority. Below is what we do to help you provide a safer working environment.

ELASTOMERS PLATES, TUBES AND PROFILES AS FORMING ELEMENT



Our product portfolio includes plates, tubes and profiles as forming elements for unconventional solutions, for sensitive surfaces and for special solutions. Our elastomers are also interesting as buffers, scrapers and ejectors. Cutting, stamping and reshaping by means of FIBROFLEX® forming materials is especially suitable for the production of small and medium series.

THE MAIN ADVANTAGES ARE...

- ... favourable expenditure of time and costs. for dimensional workpiece modifications or release series, this also means a quick response to new market or delivery time requirements.
- ... a surface-protecting manufacturing procedure. plates that are pre-coated or have a high gloss finish and must be protected from scratches or damages are gaining an increasing importance. Here, often the only alternative is reshaping by means of FIBROFLEX®.
- ... the considerably longer service life in comparison to natural and synthetic rubber types.

FIBRO-CHEMICAL TOOLING AIDS

SUPPORT BY PROCESSING ACCESSORIES

OUR PRODUCT RANGE „FIBRO CHEMICAL TOOLING AIDS“

In addition to our standard parts program, you will receive processing accessories from the „FIBROLIT® CHEMIE“ range to support tool manufacture.

- Tool cast resin
- Metal adhesives
- Quick cleaner
- Rust/corrosion releasing lubricant/agent
- Leak detector spray
- Marking out blue
- Release agent
- Oils and greases



PERIPHERAL EQUIPMENT

ELECTRONIC TAPPING UNIT – FETU

The electronic thread tapping unit, specially designed for punching and forming processes, stands out thanks to its excellent process integration. Regardless of whether the electronic thread tapping unit is used in progressive dies or progression tools, in presses or in automatic punching and bending machines, the desired threads are created in a reliable and controlled fashion. This improves thread quality, increases reliability and ensures quick, cost-effective production.

- Versatile and flexible application
- Autonomous system
- Large spectrum of thread sizes M2-M24 (larger upon request)
- Simple programming and control
- High quality
- Stability and strength
- Surface quality
- Integrated quality control

- Cost effectiveness
- Cost savings
- Short production times
- a high level of investment security



PERIPHERAL EQUIPMENT

SENSORS FOR STAMPING AND FORMING TECHNOLOGY

SENSORS = BASIS FOR PUNCHING AND FORMING PROCESSES

Close to the action, sensors convert mechanical parameters such as force, pressure, sound, vibrations, paths, positions or movements into digital or analogue signals.

Sensors are the basis for precise visualization, optimization, measurement, inspection and tracing of all punching and forming processes. FIBRO sensors have been specifically developed for punching and forming. FIBRO offers a wide range of sensors in various designs, complete with the matching installation equipment.

- Light barriers, digital, Laser
- Light barriers, digital, Infrared
- Light barriers, analogue, laser
- Laser diffuse sensor, digital
- Eddy current sensor, analogue
- PIEZO-Senzor

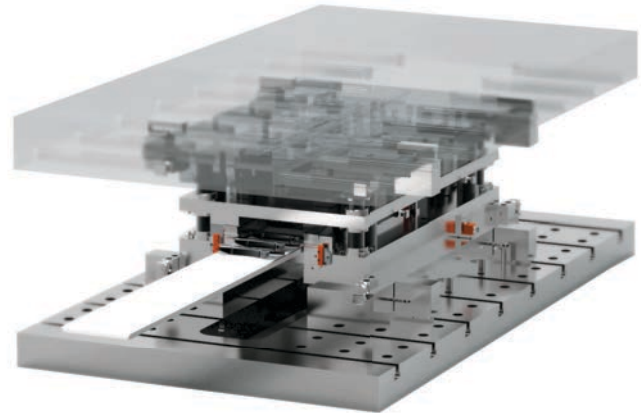

PERIPHERAL EQUIPMENT

ELECTRO-MECHANICAL TRANSPORTERS

The FIBRO Electromechanical Transporters are designed to effectively solve the problems of parts transport and removal of stamping and cutting residues from presses.

THE ADVANTAGES OF FIBRO ELECTROMECHANICAL TRANSPORTERS ARE:

- Enormous flexibility through the possibility of several and different to use their own transport channels
- Short changeover times when changing tools
- reliable
- Low volume



PERIPHERAL EQUIPMENT

PNEUMATIC CONVEYOR

This pneumatic conveyor is unique and is patented. It was designed to provide an effective and affordable solution to the problems of conveying parts and disposing of waste. This beltless system conveys stampings and waste from the tool area by vibration alone.

A specially designed guide channel which is screwed to the body of the conveyor vibrates rhythmically slowly forwards and fast backwards. The mass inertia of the parts is used to move them forwards. In this way the parts in the guide channel progress gently towards the storage containers.

The conveyor is maintenance-free and has a very low air consumption so is extremely economical in operation. The pneumatic conveyor is quiet running and very user friendly.

The conveyor was originally designed for press shop use but can be used as a conveyor with any tool. Blockages are a thing

of the past whether the conveyor is feeding parts for assembly or removing and disposing of stampings and waste parts.

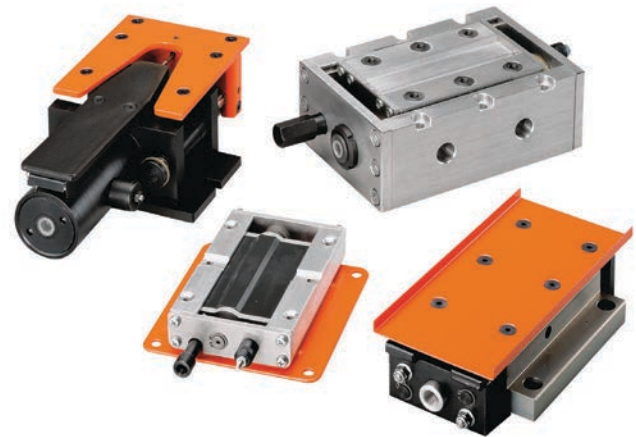

PERIPHERAL EQUIPMENT

CONVEYOR BELTS

The conveyor belts are used to remove parts and waste from presses.

They are also suitable for any other use where parts or wastes are extracted.

The conveyor belt consists of a glass fiber fabric with a coating of polyurethane.

The power take-offs are designed for continuous operation and temporary operation.



CAM UNITS

CAM SLIDE UNIT

The FIBRO cam unit program offers matching system solutions for the widest range of applications. From the use in progressive punching tools with the smallest dimensions up to the demanding use in large tools. From the use in tools with small piece numbers up to premium applications in the manufacture of bodywork parts with the highest requirements in terms of precision, lifetime and process force transmission, our cam unit program offers the matching solution to your application. The fault-free operation is guaranteed by FIBRO over the guaranteed, nominal lifetime. The design of the cam units, in the course of the tool construction, is indispensable in this regard. Operating conditions of the tool, as well as the expected environmental influences, must be taken into account to the best extent possible. Using a precise and conscientious design, it is possible to achieve a lifetime which extends far beyond the guaranteed stroke rate.



CAM UNITS

ROLLER SLIDE UNITS

The FIBRO roller slide unit has been designed to meet the increasing demand for standard slide units in tool making and the automotive industry. The slides are available for maximum stamping forces of 30kN, 50kN and 150kN. Gas springs with a restoring force of 200 daN to 500 daN according to the specific roller slide unit are used to restore the slide unit.

- Roller slide units are low maintenance and have a service life of 1 Mio. strokes
- Thanks to the guide, loads can be applied off-center
- Seating for the forces acting in the working direction and the return
- Slide can be dismantled while installed
- Gas spring can be dismantled while installed
- Small dimensions, large working surface



CAM UNITS

PUNCHING UNITS, MECHANICAL

In manufacturing press shops you are often faced with the challenge to perform a stamping or bending operation in a direction that is not the same as the working direction of the press. Usually in such situations cam units are used, which convert the vertical downwards movement of the press into a horizontal direction.

Changing the punching / bending direction during the press stroke makes it possible to create very tight positional tolerances, where an additional operation after the press process would not be economically possible.

The punching units, which are mechanical, are completing our cam unit and roller slide unit product range. Specially developed for progressive press tools, they can be used in every situation where conventional cam units show their limits.

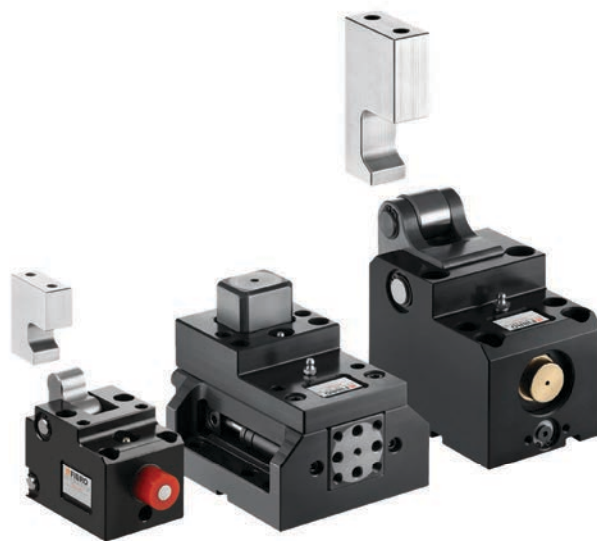

CAM UNITS

HYDRAULIC CAM SYSTEM (FLEX CAM)

Our hydraulic Flex Cam System is suitable for all applications where conventional tool slides are limited with regards to the working angle. Forming and punching processes are possible against the relative movement of the tool. This allows a further reduction in the required number of tools.

- a primary unit in the direct working area is not required
- Operations can be performed at any angle and in every direction
- High tool safety due to overload protection
- Reduces lateral forces and tool loads
- Increases force distribution in the press / tool



WE LOVE TECHNOLOGY



Order No. 2.2001.00.0220.0100000

MEMBER OF THE LÄPPLE GROUP

